

Feel Create Act in a circular way

NATURE IS THE ORIGIN OF OUR ACTIVITY AND OUR SOURCE OF INSPIRATION. THAT'S WHY WE RESPECT IT THROUGHOUT THE ENTIRE MANUFACTURING PROCESS.

2024

CATALOGUE



ASTIGARRAGA

hit line

WE ARE NATURE



REDUCTION OF CARBON FOOTPRINT

We monitor our carbon footprint and act accordingly to reduce it for the global good.



BIOMASS

We practice energy self-sufficiency, generating heat by burning biomass from the waste we generate in our manufacturing processes.



A sustainable manufacturing process

At Astigarraga Kit Line we take care of what we love most: our environment. Our forests are the lungs of our activity and that is why we promote their care and reforestation. We control the entire manufacturing chain, in a circular process that begins and ends with the planting of insignis pine trees, guaranteeing respect for the environment. In this way, we fell, saw, dry, machine, package and ship our natural furniture in an entirely local way, with control of the production process and synergies between local companies that help to maintain the future of the forests.

We care for our environment



One thing that characterises us as a company is our commitment to caring for nature. All the wood that we work with is local, sustainable and controlled, which has enabled us to be PEFC certified since 2005.

Our commitment goes further

Our responsibility is not limited to reforestation or controlled production. At Astigarraga Kit Line, we enjoy designing and manufacturing solid pine wood furniture at a reasonable price. We respect nature, and we pay attention to every detail throughout the production process. Our commitment is not only to our environment, but also to the customer, with work that begins in the forest and ends with the satisfaction of our customers when they receive the final product.

We are Ecolabel



We contribute transparent criteria to a sustainable economy by providing consumers with accurate and reliable information on the environmental performance of labelled products. This is certified by the European Commission with the Ecolabel certificate.



70% RECYCLED PLASTICS

In addition to reducing the use of plastics in our packaging, we have achieved a 70%.



RECYCLED CARDBOARD

The cardboard we use in our packaging is made from 100% recycled material.

TRADITION



FAMILY VALUES

The surname Astigarraga is the origin of our company. We started as a small, family-run local factory. However, today, Astigarraga symbolises much more than that.

Every day more and more people work with us, sharing a connection based on common values. Spending just a few minutes talking to the people who make up our team is enough to understand the passion with which they embrace the natural environment that surrounds them, the dedication they put into their work and the commitment that binds them to their clients. All this is reflected in each Astigarraga Kit Line product.

They are authentic, simple and environmentally friendly products. This is the secret that ensures that, year after year, they remain as fresh and timeless as ever.



VOCATION



PASSION FOR CUSTOMER SERVICE

We have almost 40 years' experience in the DIY sector, and we are European leaders in the manufacture of wooden trestles. As a result, in our catalogue, you will find all kinds of products for organisation, with a young and innovative design that stands the test of time. Our goal is excellence in customer service. And we work for and with our customers. So that they can transform a home, office or work area into a more responsible space. With quality, and design. We're betting on the future.





I

FUNCTIONALITY AND AESTHETICS

TRESTLES AND BOARDS

We often talk about the satisfaction of a job well done, but very little about how we do it. Our trestles and tabletops, for example, are simple furniture developed from the perfect combination of practicality and aesthetics.

Every job is a world and every trestle is a range of possibilities. We provide the quality and the experience, the intended use is left to the user's choice and imagination.



WORK TRESTLES

Just like each task requires a specific tool, each professional needs a special easel. This is the reason for the variety in the designs of our easels - our speciality.

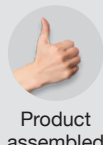
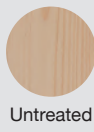

Solid pine wood

Untreated

Product assembled

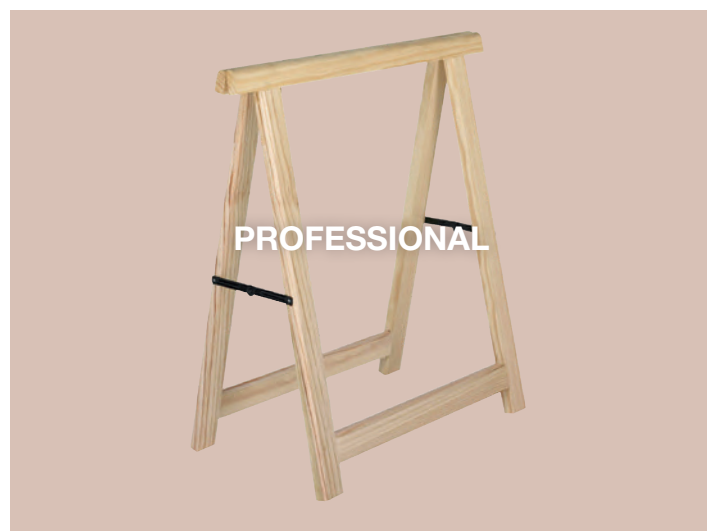



STANDARD
 Standard pine trestle
 REF. CAB001.99
 EAN 8422341100010

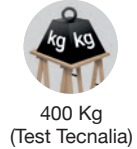
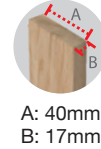
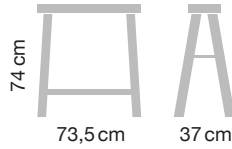

PROFESSIONAL
 Pine professional trestle
 REF. CAB002.99
 EAN 8422341100027

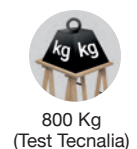
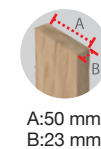
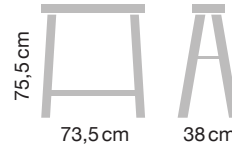

PROFESSIONAL MINI
 Pine Professional trestle for small spaces
 REF. CAB015.99
 EAN 8422341199359

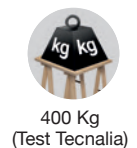
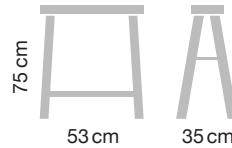

PRO HEIGHT
 1 Meter pro height pine trestle
 REF. CAB013.99
 EAN 8422341199335

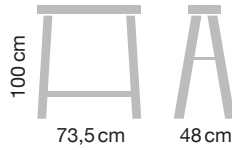

STRONG
 Strong pine trestle
 REF. CAB014.99
 EAN 8422341199342

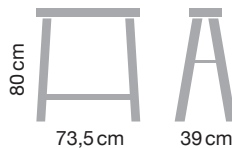

TAPISSIER
 Pine Tapisier trestle
 REF. CABTAP.99
 EAN 8422341199441

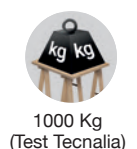
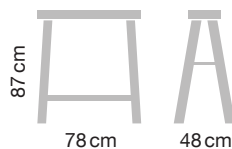

KIPLI
 Foldable pine trestle
 REF. CAB023.99
 EAN 8422341199199

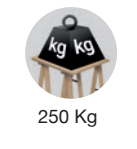
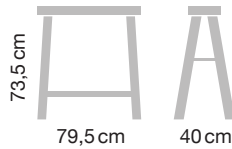

I. TRESTLES AND BOARDS



STANDARD Standard pine trestle



Solid pine wood



Untreated



A: 40mm
B: 17mm



400 Kg
(Test Tecnalia)



Product assembled

Units per pack: 35
Minimum order: 2 Packs



REF. CAB001.99
EAN 8422341100010





PROFESSIONAL
Pine professional trestle



Solid pine wood



Untreated



A: 50mm
B: 23mm



800 Kg
(Test Tecnalia)



Product assembled

Units per pack: 24
Minimum order: 2 Packs



REF. CAB002.99
EAN 8422341100027



I. TRESTLES AND BOARDS

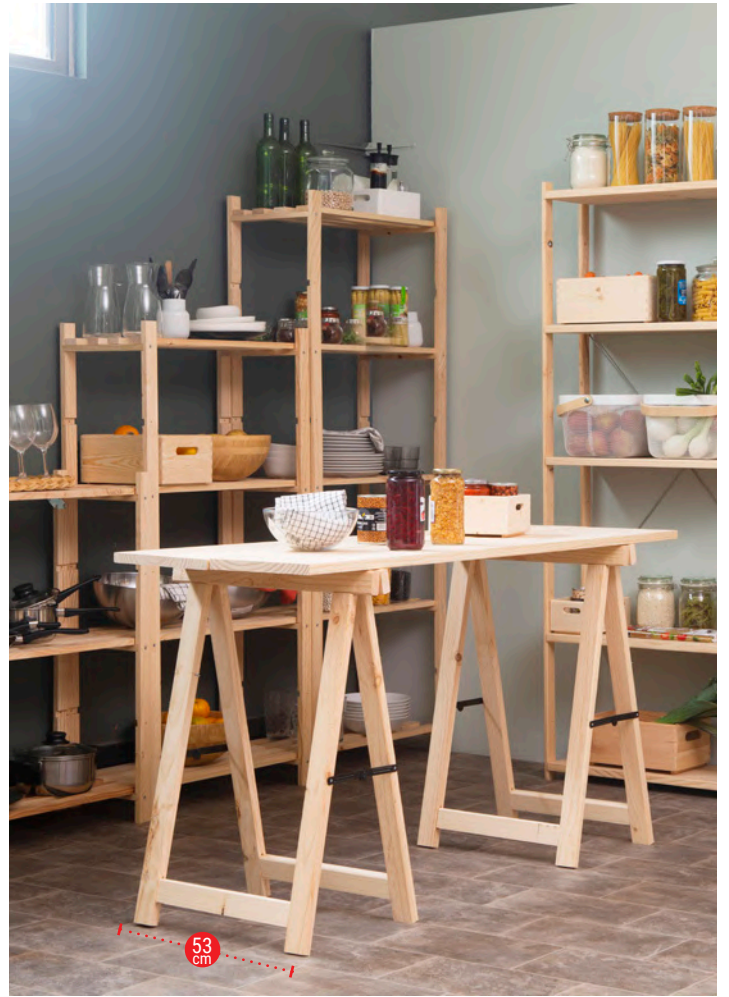

PROFESSIONAL MINI Pine professional trestle for small spaces



Solid pine
wood



Untreated



A: 50mm
B: 23mm



400 Kg
(Test Tecnalia)



Product
assembled

Units per pack: 12
Minimum order: 1 Pack

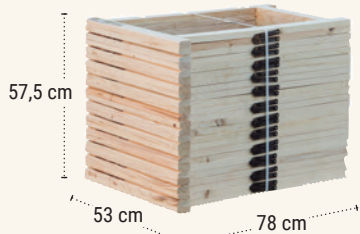

REF. CAB015.99
EAN 8422341199359





PRO HEIGHT >
1 Meter pro height pine trestle

REF. CAB013.99
 EAN 8422341199335



ES.EU / 049 / 00001



PEFC/14-38-00151



Untreated



Solid pine wood



A: 50mm
 B: 23mm



800 Kg
 (Test Tecnalia)



Product assembled

Units per pack: 16
 Minimum order: 1 Pack



I. TRESTLES AND BOARDS



STRONG Strong pine trestle



ES.EU / 049 / 00001



PEFC/14-38-00151



Solid pine wood



Untreated



Product assembled



1200 Kg (Test Tecnalia)

Units per pack: 10
Minimum order: 1 Pack



REF. CAB014.99
EAN 8422341199342

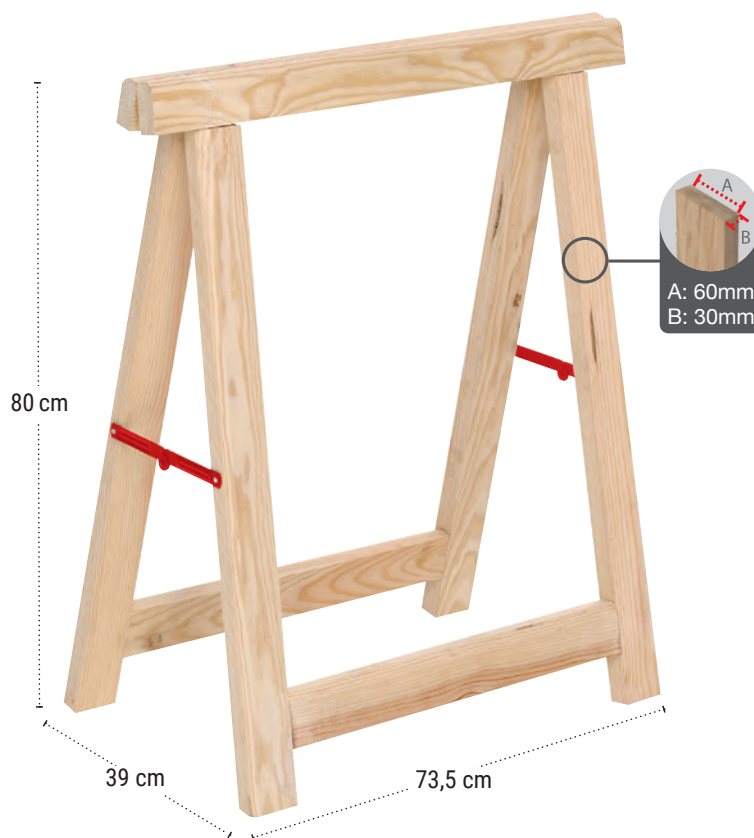

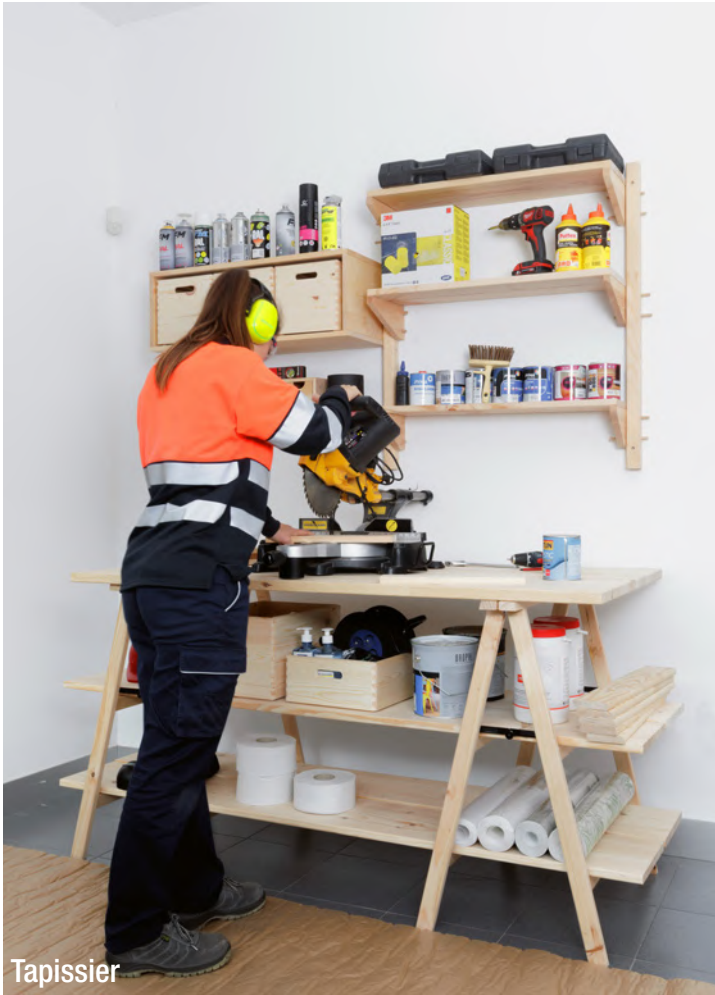

Tapissier



Kipli



Kipli

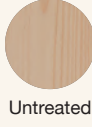

Solid pine wood
Untreated
Product assembled
1000 Kg (Test Tecnalia)

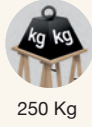
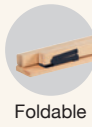

Solid pine wood
Untreated
Product assembled
Foldable
250 Kg

TAPISSIER
Pine Tapissier trestle

REF. CABTAP.99
EAN 8422341199441
Minimum order: 1

KIPLI
Foldable trestle
Int.Patent. W0/2007/107669

REF. CAB023.99
EAN 8422341199199
Product without packaging: 79,5 x 9 x 6cm
Minimum order: 1

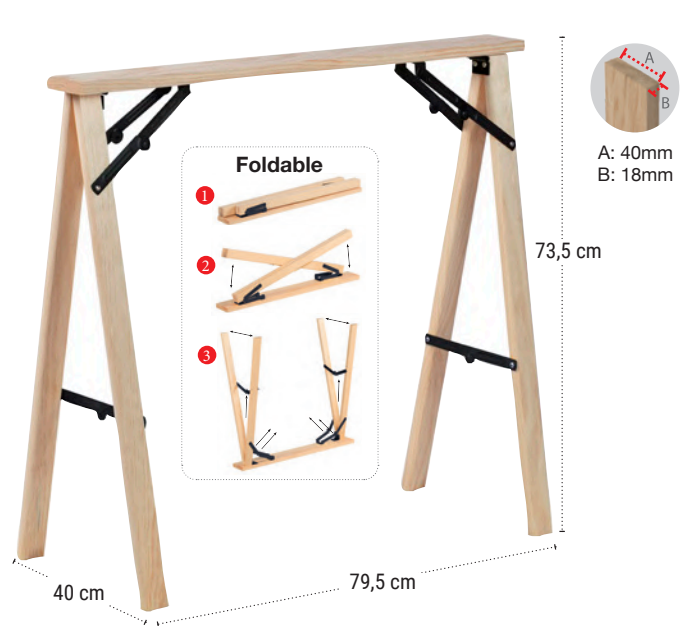

I. TRESTLES AND BOARDS



**DECORA
WORKTOP**



Solid pine wood



Untreated



Packet wooden worktop



REF. EN1680.99
EAN 8422341299295
Packed product: 160 x 80 x 3cm.



REF. EN1470.99
EAN 8422341299288
Packed product: 140 x 70 x 3cm.

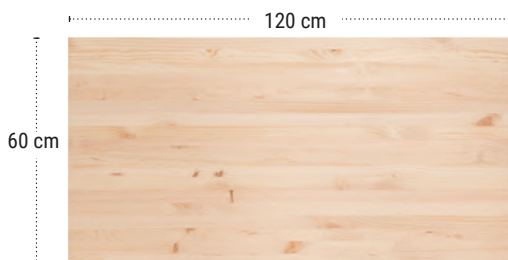

REF. ENC126.99
EAN 8422341299851
Packed product: 120 x 60 x 1,8cm.



REF. ENDI75.99
EAN 8422341299301
Packed product: 75 x 75 x 3cm.

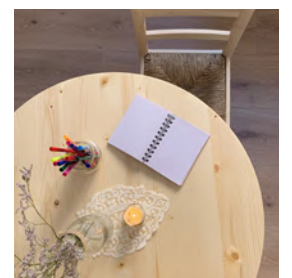



**DECORA FOLDING
WALL TABLE**



Solid pine
wood

Untreated

18 mm

60 Kg
(Test Tecnalia)

Foldable

Assembly
required

Wall mounting
included



REF.TMPL15.99
EAN 8422341299318
Packed product: 80 x 52 x 4,7 cm



Foldable

I. TRESTLES AND BOARDS



LEGS

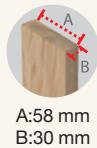

Units per pack: 1
Packed product:
71 x 12 x 9 cm

REF.PIEXL2.99
EAN 8422341699262

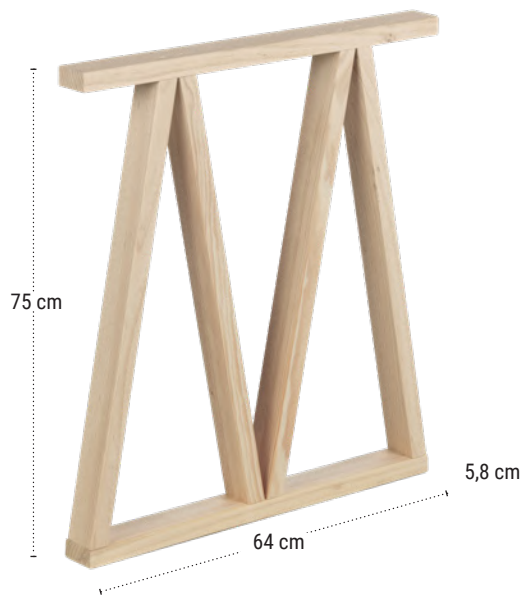

2 positions



Position 1



Position 2

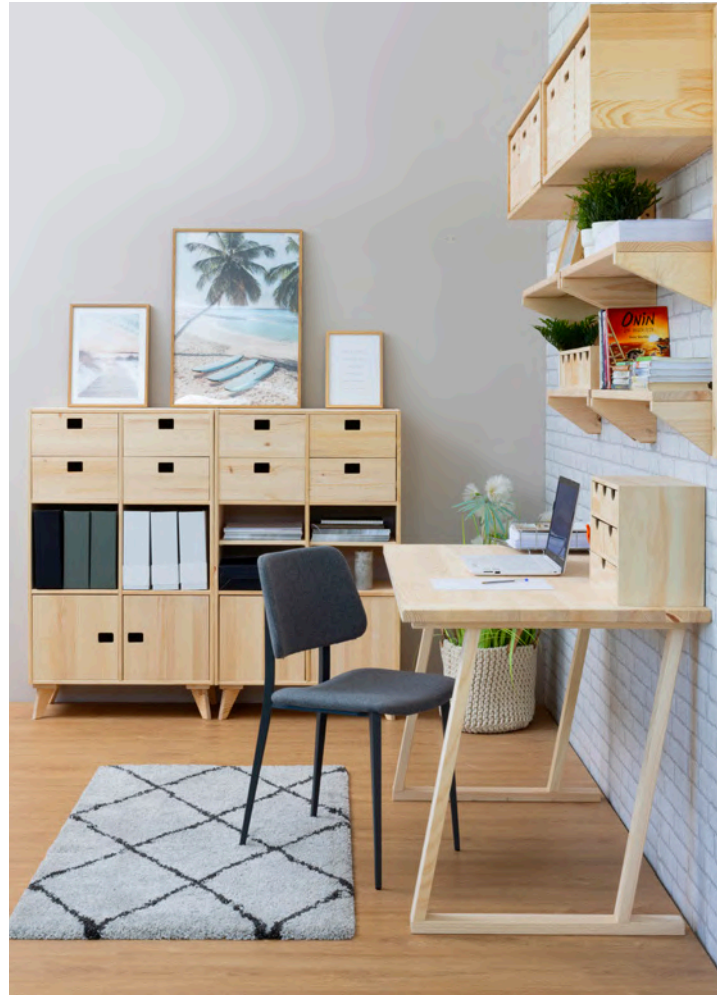

REF.PIELL4.99
EAN 8422341699255

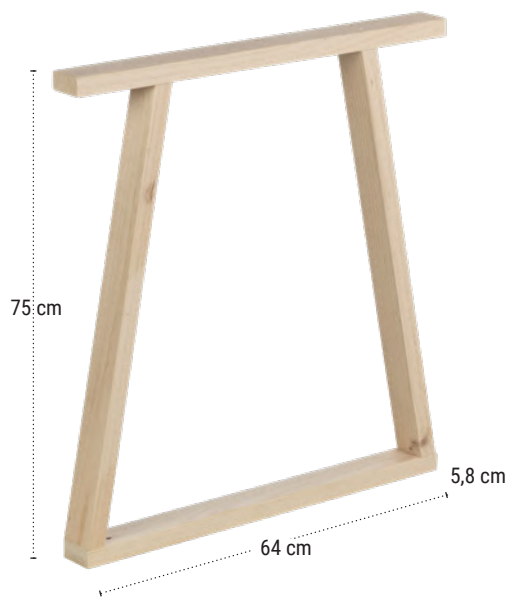

4 positions

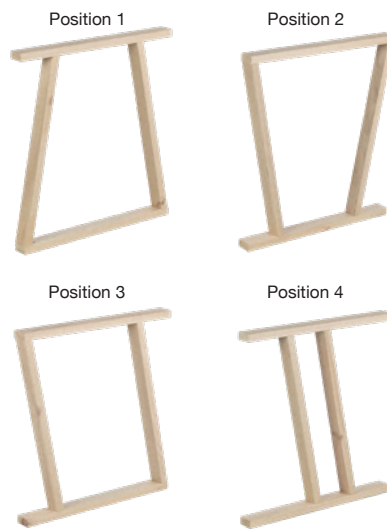

Assembly
required



100 Kg
(Test Tecnalia)



Units per pack: 1
Packed product:
71 x 12 x 6 cm



Position 1



Position 2



Position 3



Position 4

All packaging measures shown in this catalog are expressed in Length X Width X Depth

I. TRESTLES AND BOARDS



DIY Ideas

GLAM > Pine trestle for small spaces



ES.EU / 049 / 00001



PEFC/14-38-00151



Solid pine wood



Untreated



A: 70 mm
B: 20 mm



400 Kg
(Test Tecnalia)



Assembly required



Units per pack: 1
Packed product:
77 x 14 x 8cm

REF. CABGLA.99
EAN 8422341199427

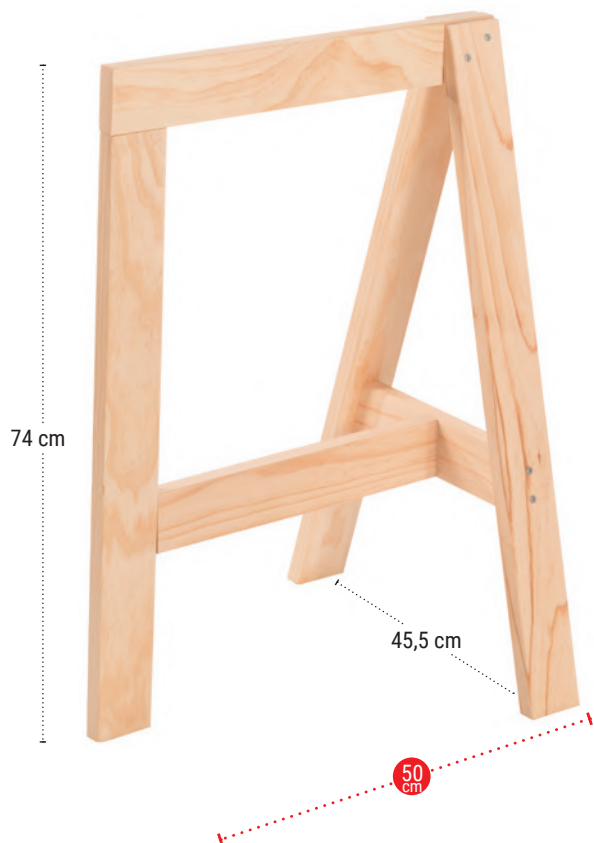



DECO >
Deco pine trestle



PEFC/14-38-00151



Solid pine wood



Untreated



20 mm



400 Kg
(Test Tecnalia)



Assembly required



Units per pack: 1
Packed product:
75 x 20 x 5cm

REF. CAB018.99
EAN 8422341199090



REF. CAB018.88
EAN 8422341158097



White
Dyed

REF. CAB018.59
EAN 8422341159094



Dyed
Black

I. TRESTLES AND BOARDS



ARCHI TEC

Adjustable in height pine
trestle archi tec



ES.EU / 049 / 00001



PEFC/14-38-00151



Solid pine
wood

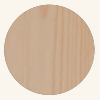

Untreated



400 Kg
(Test Tecnalia)



Assembly
required



Units per pack: 1
Packed product:
71,5 x 18,5 x 11cm

REF. CAB005.99
EAN 8422341200031



REF. CAB005.58
EAN 8422341256038



White
Dyed

REF. CAB005.59
EAN 8422341257035



Dyed
Black



STOOL- FOLDABLE LADDER

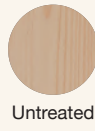
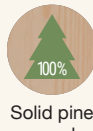

100%
Solid pine
wood

Untreated



Packed
product



UNE-EN
14183:2004
(Test Tecnia)



100kg
(Test Tecnia)



Assembly
required



17 mm

FOOTREST

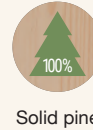

PEFC
PEFC/14-38-00151

100%
Solid pine
wood

Untreated

18 mm

Product
assembled

REF. MARC04.99

EAN 8422341499435

Packed product: 39 x 46,5 x 10 cm



Foldable

REF. MARC02.99

EAN 8422341499275

Product without packaging: 38,5 x 19 x 21cm.

Minimum order: 8





II

ORDER AND PERSONALITY

SHELVING AND WALL SHELVES

Every object we keep in our home, office or work area tells a story. Our shelf space and wall shelves are designed to give that character to spaces, placing on them everything that identifies us or simply adds decorative value to the room.

Our furniture evokes stories, memories and, ultimately, the personality of each individual. With our shelves we create the perfect place to display those photographs, books and objects that tell so much about us.



SERIE

NOVA

Wall organiser panel

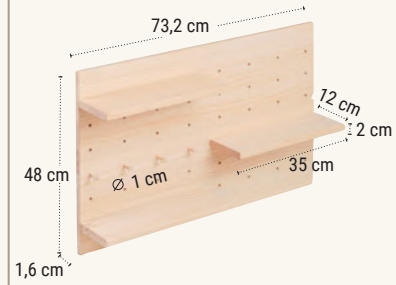

REF.NVPN00.99
EAN 8422341699408
Packed product:
74 x 49 x 4 cm

5 shelves shelf



REF.NVET50.99
EAN 8422341699354
Packed product:
174,5 x 37 x 9,5 cm

3 shelves shelf

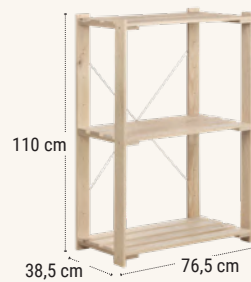

REF.NVET30.99
EAN 8422341699361
Packed product:
110,5 x 37 x 9,5 cm

Tall dressing shelf



REF. NVPE40.99
EAN 8422341699378
Packed product:
174,5 x 37x 6,2 cm

Petit dressing shelf

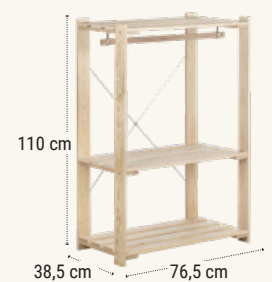

REF.NVPE30.99
EAN 8422341699385
Packed product:
110,5 x 37x 9,5 cm

Large cupboard



REF.NVARXL.99
EAN 8422341699217
Packed product:
82 x 46 x 5,5 cm

Small cupboard

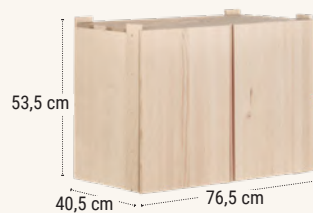

REF.NVARSS.99
EAN 8422341699224
Packed product:
57 x 46 x 5,5 cm

Big box



REF.NVCSXL.99
EAN 8422341699231
Packed product:
68 x 29 x 10 cm

Small box

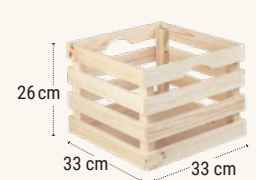

REF.NVCSSS.99
EAN 8422341699248
Packed product:
32 x 36 x 10 cm

Union table top

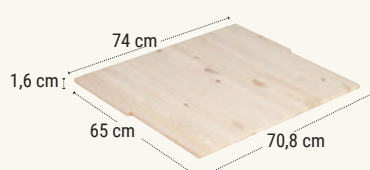

REF.NVME00.99
EAN 8422341699415
Packed product:
74 x 66 x 2cm

Removable tray

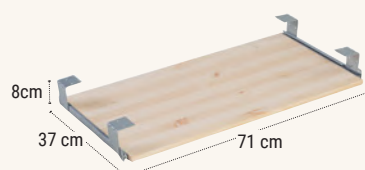

REF.NVEX00.99
EAN 8422341699422
Packed product:
84 x 39 x 6cm

Bottle adapter

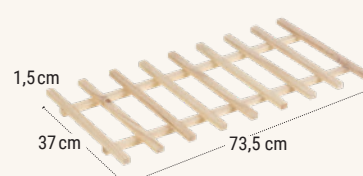

REF. NVWR00.99
EAN 8422341699200
Packed product: 73,4
x 37 x 3 cm

Additional shelf

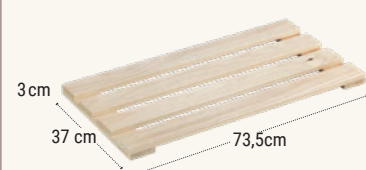

REF. NVBB00.99
EAN 8422341699194
Product without packaging:
73,5 x 37 x 3 cm



II. SHELVING AND WALL SHELVES



NOVA



PEFC/14-38-00151



Solid pine wood



Untreated



A: 70 mm
B: 15 mm



Shelves adjustable in height



100 Kg (Test Tecnalia)



Assembly required



Wall mounting included



5 shelves Nova shelf



REF. NVET50.99

EAN 8422341699354

Packed product: 174,5 x 37 x 9,5 cm

3 shelves Nova shelf

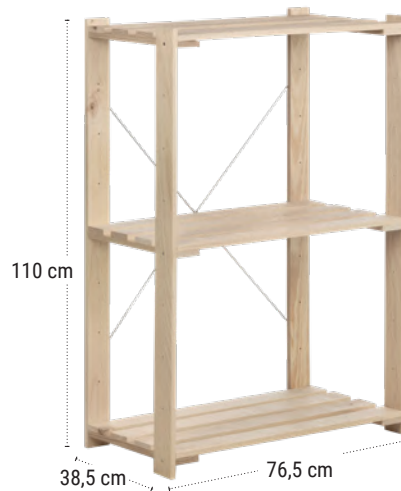

REF. NVET30.99

EAN 8422341699361

Packed product: 110,5 x 37 x 9,5 cm

Accessories



Product assembled

Additional shelf



REF. NVBB00.99

EAN 8422341699194

Product without packaging: 73,5 x 37 x 3 cm

Bottle adapter

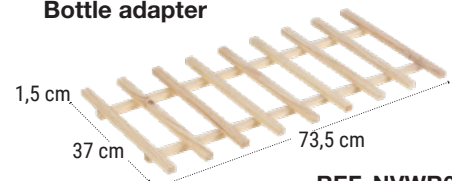

REF. NVWR00.99

EAN 8422341699200

Packed product: 73,4 x 37 x 3 cm



REF. NVWR00.99

REF. NVBB00.99



Tall Nova dressing shelf



REF. NVPE40.99
 EAN 8422341699378
 Packed product: 174,5 x 37x 6,2 cm

Petit Nova dressing shelf



REF. NVPE30.99
 EAN 8422341699385
 Packed product: 110,5 x 37x 9,5 cm

Small Nova box

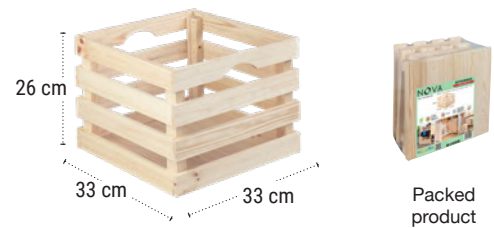

REF. NVCSSS.99
 EAN 8422341699248
 Packed product: 32 x 36 x 10 cm

Big Nova box



REF. NVCSSL.99
 EAN 8422341699231
 Packed product: 68 x 29 x 10 cm

II. SHELVING AND WALL SHELVES



NOVA

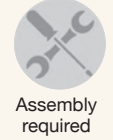

Large Nova cupboard suitable for all Nova shelves

Small Nova cupboard suitable for all Nova shelves



REF.NVARXL.99
 EAN 8422341699217
 Packed product: 82 x 46 x 5,5 cm

REF.NVARSS.99
 EAN 8422341699224
 Packed product: 57 x 46 x 5,5 cm



Packed product



Packed product

Removable NOVA tray

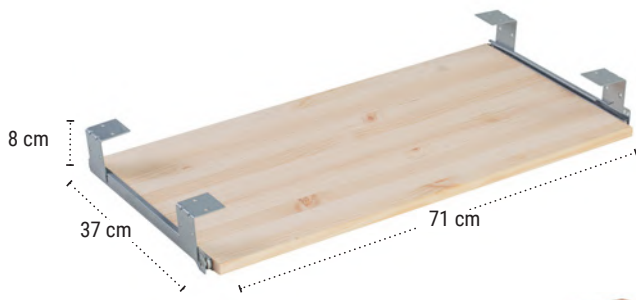

REF.NVEX00.99
 EAN 8422341699422
 Packed product: 84 x 39 x 6 cm

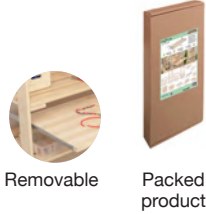

Removable Packed product



Union NOVA table top

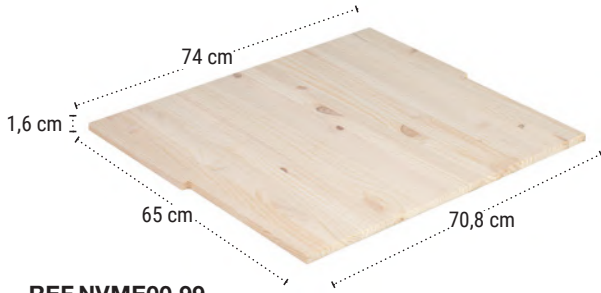

REF.NVME00.99
 EAN 8422341699415
 Packed product: 74 x 66 x 2 cm



35 Kg (Test Tecnia) Shelf fixation included Packed product



Wall organiser NOVA panel

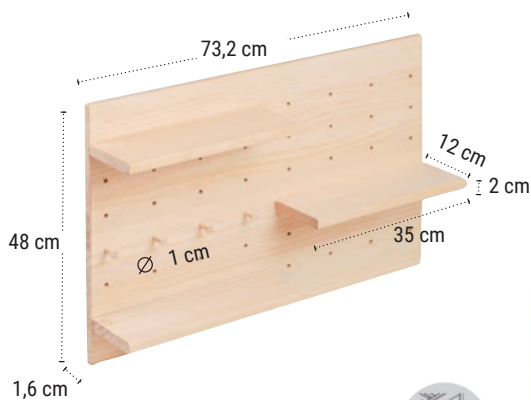

REF.NVPN00.99
 EAN 8422341699408
 Packed product: 74 x 49 x 4 cm



Shelf and wall fixings included Packed product



II. SHELVING AND WALL SHELVES



NATURA Basic shelves

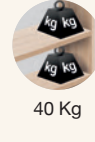
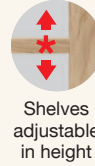
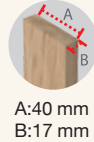

REF. NC5400.99
EAN 8422341599746
Packed product: 171 x 38 x 8,5cm.



REF. NC5300.99
EAN 8422341599760
Packed product: 171 x 28 x 8,5cm.



REF. NC4300.99
EAN 8422341599845
Packed product: 138 x 28 x 7cm.

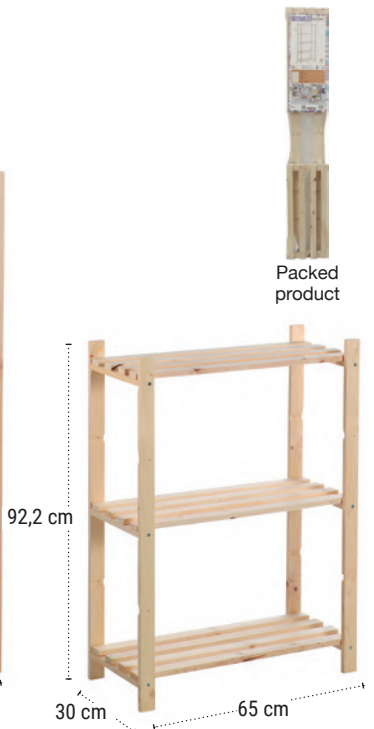

REF. NC3300.99
EAN 8422341599777
Packed product: 92,5 x 28 x 11cm.



NATURA
Shelf with solid
board shelves



Assembly
required



Wall mounting
included

NATURA
Wooden drawers



ES.EU / 049 / 00001



16 mm



Product
assembled

REF. NAT565.99

EAN 8422341599012

Packed product:
186 x 25 x 7,6cm.



50 Kg



Baldas
regulables
en altura



A:40 mm
B:15 mm



20 mm



Packed
product

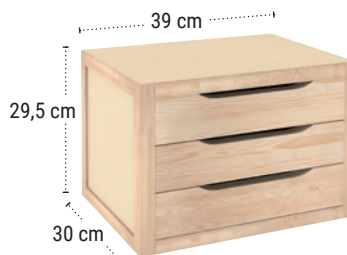

REF. BLNA30.99

EAN 8422341499800

Product without packaging:
39 x 30 x 29,5cm.

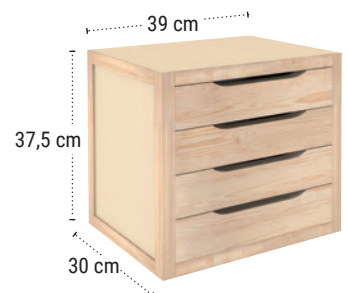

REF. BLNA40.99

EAN 8422341499817

Product without packaging:
39 x 30 x 37,5cm.

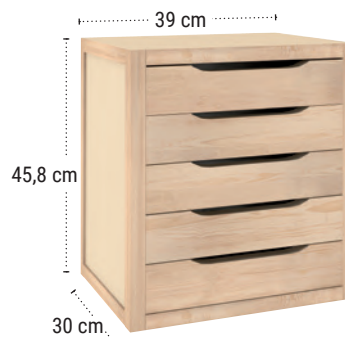

REF. BLNA50.99

EAN 8422341499824

Product without packaging:
39 x 30 x 45,8cm.

II. SHELVING AND WALL SHELVES



DINAMIC Cubes



Watch the Dinamic video



ES.EU / 049 / 00001



PEFC/14-38-00151



Solid pine wood



Untreated



50 Kg



16 mm



Assembly required



Packed product



REF. DMC500.99
EAN 8422341499718
Packed product:
176,5 x 34 x 7cm.



REF. DMC400.99
EAN 8422341499688
Packed product:
142 x 34 x 7cm.

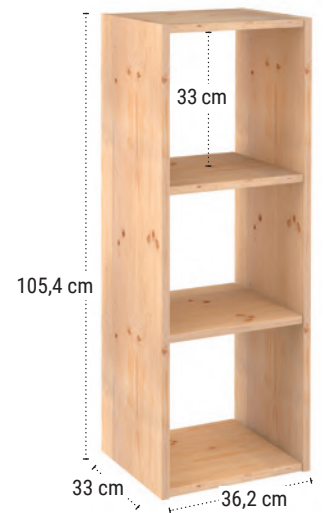

REF. DMC300.99
EAN 8422341499671
Packed product:
107 x 34 x 7cm.

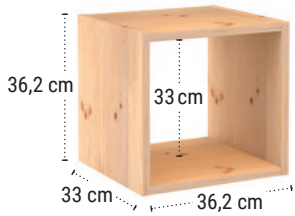

REF. DMC100.99
 EAN 8422341499657
 Packed product: 36,5 x 33 x 6,5cm.

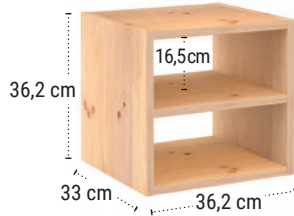

REF. DMC120.99
 EAN 8422341499756
 Packed product: 36,5 x 33 x 8cm.

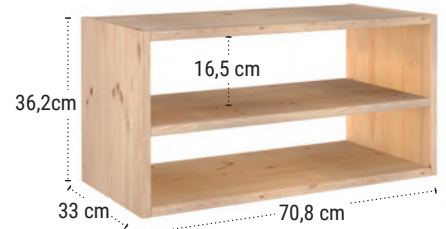

REF. DMC2TV.99
 EAN 8422341499848
 Packed product: 72 x 34 x 7cm.

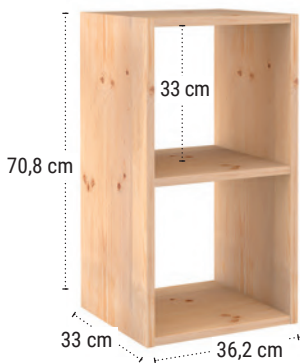

REF. DMC200.99
 EAN 8422341499664
 Packed product: 72 x 34 x 7cm.

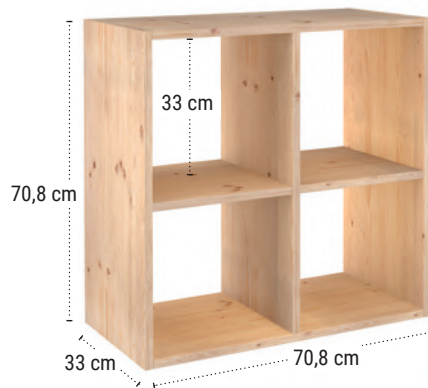

REF. DMC2X2.99
 EAN 8422341499855
 Packed product: 72 x 34 x 11cm.

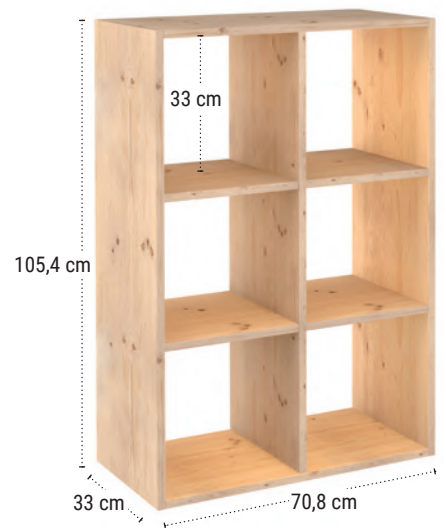

REF. DMC3X2.99
 EAN 8422341499862
 Packed product: 107x34x11cm.

II. SHELVING AND WALL SHELVES



DINAMIC Accessories



Watch the Dinamic
video



ES.EU / 049 / 00001



PEFC/14-38-00151



Solid pine
wood



Untreated



Packed
product



Packed
product

BOX

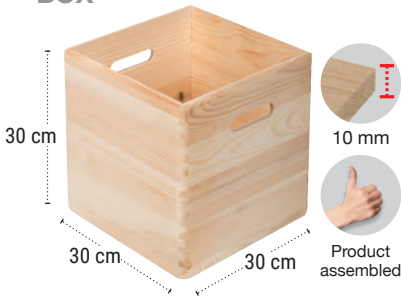

REF. CBS303030

EAN 8422341499053

Product without packaging: 30 x 30 x 30cm.

2 DRAWERS MODULE



REF. DMCAJ2.99

EAN 8422341499763

Packed product: 36,5 x 34 x 36,5cm.

3 DRAWERS MODULE



REF. DMCAJO.99

EAN 8422341499695

Packed product: 36,5 x 34 x 36,5cm.

SET OF 2 LEGS



REF. DINPIE.99

EAN 8422341499633

Packed product:
35,3 x 11,7 x 6,5cm.



A: 17 mm
B: 20 mm



150Kg
(Test Tecnalia)



Assembly
required

BOTELLERO

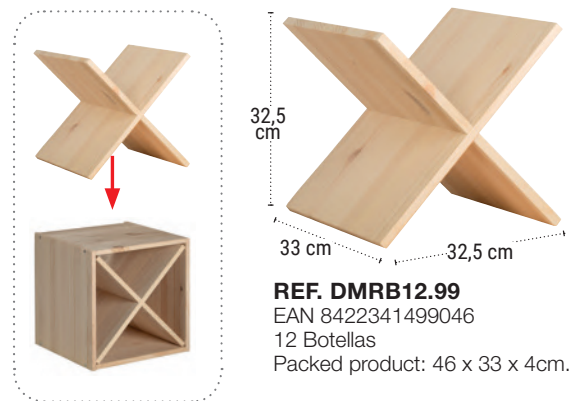

REF. DMRB12.99

EAN 8422341499046

12 Botellas
Packed product: 46 x 33 x 4cm.



Assembly required



16 mm

2 KIT DRAWERS

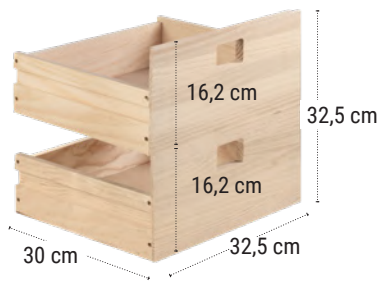

REF.DMDR20.99
EAN 8422341699323
Packed product:
36 x 33 x 4 cm



Packed product

DOOR

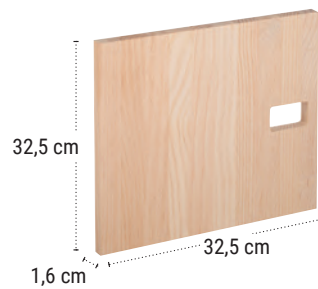

REF. DMPS00.99
EAN 8422341499060
Packed product:
39 x 34,5 x 3cm.



Hinge cup included



Packed product

SHELF

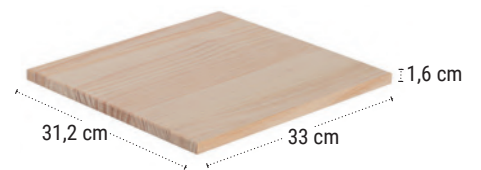

REF. DMBB00.99
EAN 8422341499015
Packed product: 35 x
32 x 2,5cm.



Packed product



Hardware included

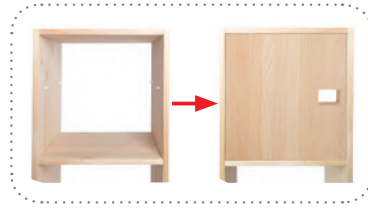

Hardware included

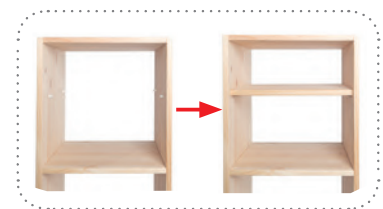

Hardware included

II. ESTANTERÍAS Y ESTANTES MURALES



DIY Ideas

DINAMIC Furniture



ES.EU / 049 / 00001



PEFC/14-38-00151



Solid pine wood



Untreated



16 mm



Shelves adjustable in height



50 Kg



Assembly required



Packed product



REF. DM1VER.99
EAN 8422341499565
Packed product:
55 x 36 x 11,5cm.



REF. DM2VER.99
EAN 8422341499572
Packed product:
107 x 36 x 9,5cm.



REF. DM2HOR.99
 EAN 8422341499589
 Packed product:
 69,5 x 36 x 13cm.



REF. DMC4P0.99
 EAN 8422341499244
 Packed product:
 103 x 34,5 x 18cm.

II. SHELVING AND WALL SHELVES



GALA

Shelves adjustable in height



Ver videoGala



ES.EU / 049 / 00001



PEFC/14-38-00151



Solid pine wood



Untreated



20 mm



Solid board



Shelves adjustable in height



100 Kg (Test Tecnalia)



Assembly required



Packed product



REF. GAL750.99

EAN 8422341599524
Packed product:
217 x 25 x 9cm.



REF. GAL650.99

EAN 8422341599500
Packed product:
185 x 25 x 9cm.



REF. GAL450.99

EAN 8422341599487
Packed product:
121 x 25 x 11,5cm.



REF. GAL780.99
 EAN 8422341599531
 Packed product: 217 x 25 x 13cm.



REF. GAL680.99
 EAN 8422341599517
 Packed product: 185 x 25 x 13cm.



REF. GAL480.99
 EAN 8422341599494
 Packed product: 121 x 25 x 15cm.

II. SHELVING AND WALL SHELVES



GALA CORNER SHELF

Shelves adjustable in height



ES.EU / 049 / 00001



PEFC/14-38-00151



Solid pine wood



Untreated



20 mm



Solid board



Shelves adjustable in height



100 Kg (Test Tecnalia)



Assembly required



REF. GALR60.99

EAN 8422341599555

Packed product: 185 x 25 x 7,5cm.

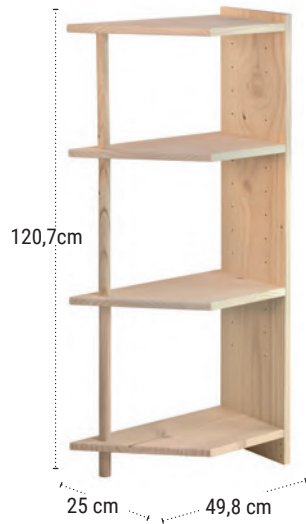

REF. GALR40.99

EAN 8422341599548

Packed product: 121 x 25 x 7,5cm.



One reference, four positions

1 Left end

2 Right end



3 External angle



4 Internal angle



GALA >
Accessories



16 mm



20 mm

2 gala doors kit for 79,6 cm width shelves
REF.GAPT80.99

EAN 8422341699286

Packed product: 44 x 38,5 x 4,5 cm

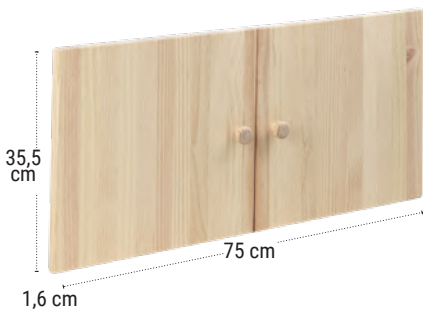

Gala shelf for 79,6 cm width shelves
REF.GABB80.99

EAN 8422341699309

Packed product: 75,6 x 25,5 x 2 cm



1 Gala door kit for 49,6 cm width shelves
REF.GAPT50.99

EAN 8422341699293

Packed product: 52,5 x 38 x 3,3 cm

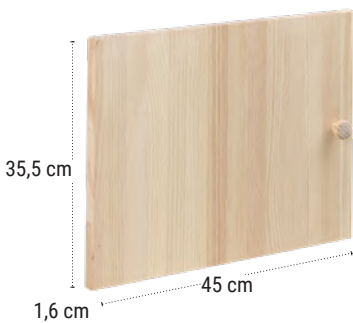

Gala shelf for 49,6 cm width shelves
REF.GABB50.99

EAN 8422341699316

Packed product: 45,6 x 25,5 x 2 cm

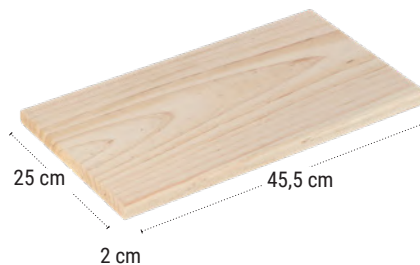

II. SHELVING AND WALL SHELVES



TRIANGLE Wooden shelves



Solid pine
wood

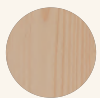

Untreated



20 mm



Solid
board



Modulated
edges



Packed
product

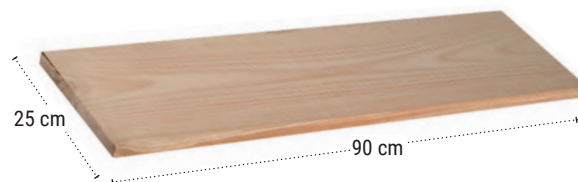

REF TRI925.99

EAN 8422341299325

Packed product: 90 x 25 x 2 cm



REF TRI625.99

EAN 8422341299332

Packed product: 60 x 25 x 2 cm



REF TRI917.99

EAN 8422341299349

Packed product: 90 x 17 x 2 cm

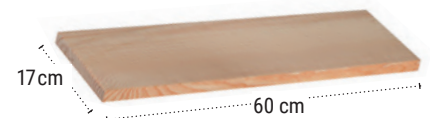

REF TRI617.99

EAN 8422341299356

Packed product: 60 x 17 x 2 cm

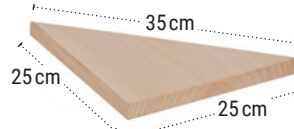

REF TRIE25.99

EAN 8422341299363

Packed product: 25 x 25 x 2 cm



TRIANGLE Wooden brackets

Easy to place in multiple positions to create different and infinite decorative and functional compositions



ES.EU / 049 / 00001



PEFC/14-38-00151



Watch the Triangle video



Solid pine wood



Untreated



17 mm

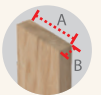

A:22 mm
B:10 mm



20 Kg
(Test Tecnalia)



Product assembled



Packed product

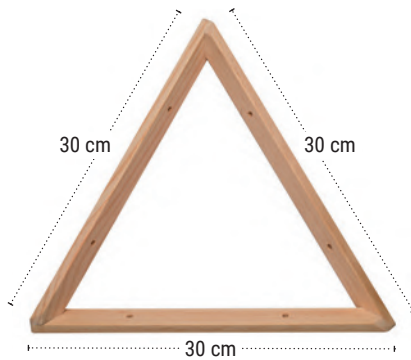

Minimum width 22 cm

REF. TRI300.99

EAN 8422341399209
Packed product: 32,5 x 35 x 2,5cm.
Minimum order: 20 unidades

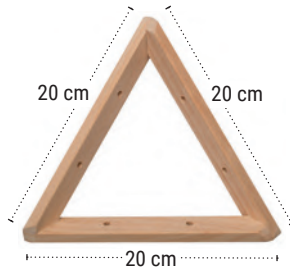

Minimum width 15 cm

REF. TRI200.99

EAN 8422341399216
Packed product: 24 x 25 x 2,5cm.
Minimum order: 20 unidades

SHELVES AND BRACKETS EXHIBITOR

Ref. RACKTRCOM
EAN 8422341699132



FOTO	REF.	UD.
	TRI925.99	24
	TRI625.99	24
	TRI617.99	24
	TRI917.99	24
	TRIE25.99	24
	TRI300.99	20
	TRI200.99	20

II. SHELVING AND WALL SHELVES



LONGUE WALL SHELVES

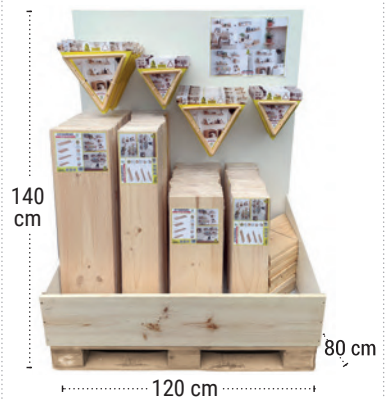
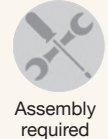
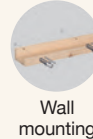
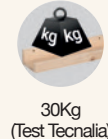
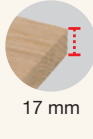

REF. EMSP80.99
EAN 8422341699040
Packed product: 80 x 11,5 x 3,5cm



REF. EMEP80.99
EAN 8422341699019
Packed product: 80 x 15 x 5,2cm

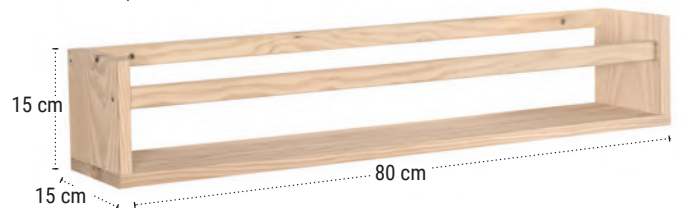

REF. EMSP60.99
EAN 8422341699057
Packed product: 60 x 11,5 x 3,5cm

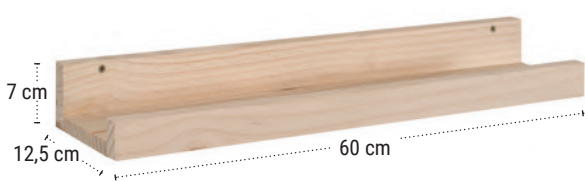

REF. EMEP60.99
EAN 8422341699026
Packed product: 60 x 15 x 5,2cm



REF. EMSP40.99
EAN 8422341699064
Packed product: 40 x 11,5 x 3,5cm



Packed product

REF. EMEP40.99
EAN 8422341699033
Packed product: 40 x 15 x 5,2cm



Packed product



ORGANISER PANEL WALL >

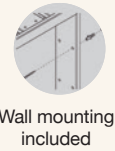
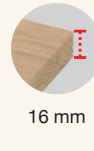
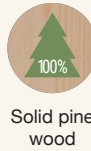

Solid pine wood

Untreated

16 mm

Assembly required

Wall mounting included

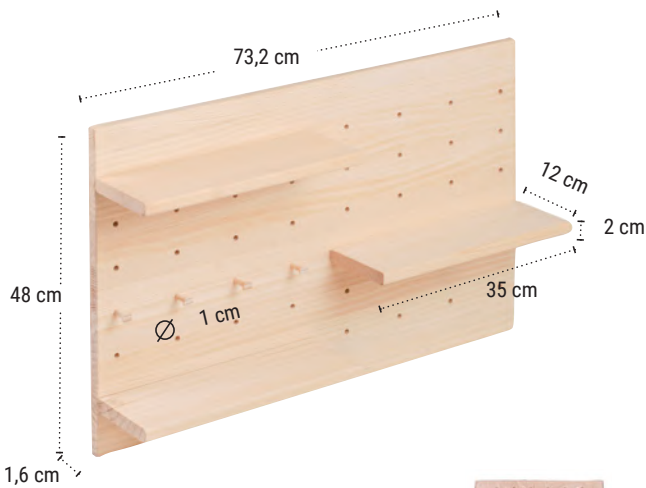

REF.NVPN00.99
EAN 8422341699408
Packed product: 74 x 49 x 4 cm



Packed product

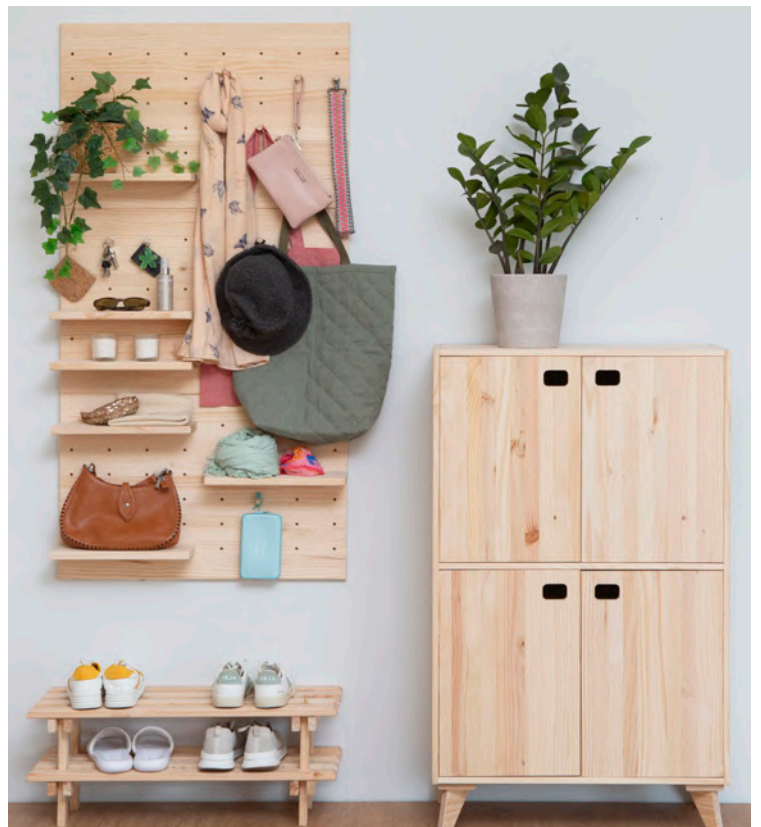





III

ORGANISATION AND EFFICIENCY

BOXES AND DRAWERS

Nothing provides more peace than having everything well organised. Always finding what you're looking for the first time is a rare pleasure, but with our boxes and drawer units, it can become a recurring theme.

How much time do we waste looking for things that we can't remember where we've last left them? Thanks to our furniture it is possible to organise all the necessary things, so that we can always have them located and spend our free time doing what makes us happy.

III. BOXES AND DRAWERS



MINI DRAWERS BLOC

Multipurpose wooden drawers



ES.EU / 049 / 00001



PEFC/14-38-00151



Solid pine veneer



Product assembled



Untreated



11 mm

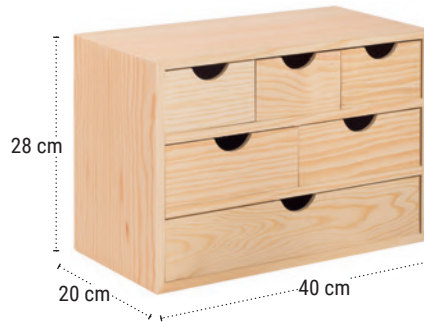

REF. BLP321.99

EAN 8422341499787

Product without packaging: 40 x 20 x 28cm.

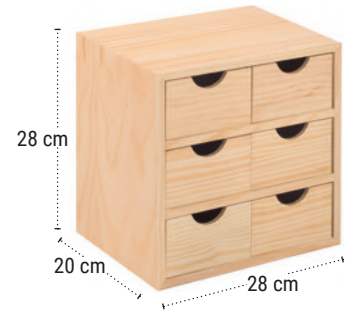

REF. BLP320.99

EAN 8422341499770

Product without packaging: 28 x 20 x 28cm.

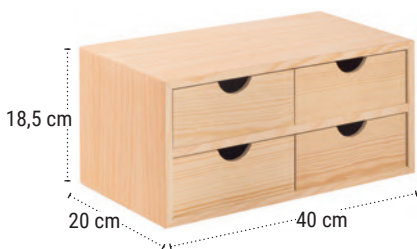

REF. BLP220.99

EAN 8422341499091

Product without packaging: 40 x 20 x 18,5cm.



REF. BLP510.99

EAN 8422341499794

Product without packaging: 57 x 13 x 12cm.



REF. BLP310.99

EAN 8422341499084

Product without packaging: 21 x 20 x 28cm.



Ver video
Home Box



Modular wooden boxes



ES.EU / 049 / 00001



Assembly
required



Solid pine
wood



PEFC/14-38-00151

NOVA
Boxes

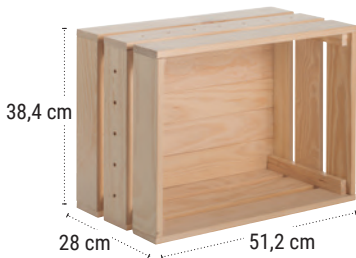

REF. HOME01.99

EAN 8422341599210

Packed product: 56,2 x 36 x 7cm.



Stackable and nestable in
multiple positions

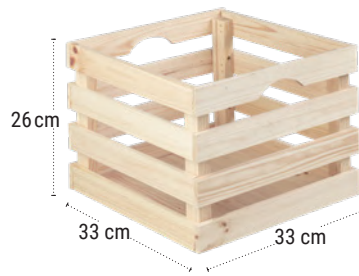

A:43 mm
B:10 mm

Small Nova box

REF.NVCSSS.99

EAN 8422341699248

Packed product:

32 x 36 x 10 cm



Packed
product

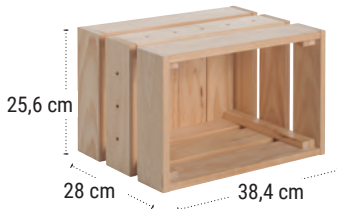

REF. HOME02.99

EAN 8422341599227

Packed product: 36 x 32,5 x 7cm.



Packed
product

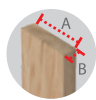

A:80 mm
B:13 mm



A:70 mm
B:15 mm

Big Nova box

REF.NVCSXL.99

EAN 8422341699231

Packed product:

68 x 29 x 10 cm

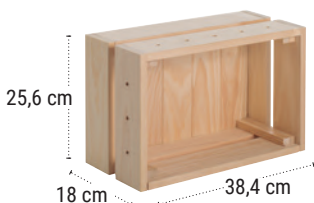

REF. HOME03.99

EAN 8422341599234

Packed product: 37 x 26 x 7cm.

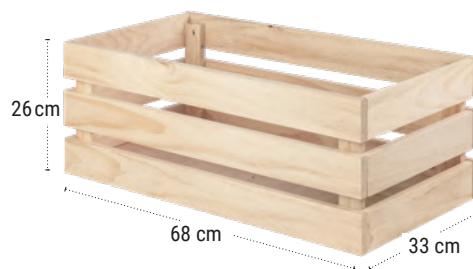

Packed
product

III. BOXES AND DRAWERS



WOODEN BOXES AND COVERS



Solid pine wood

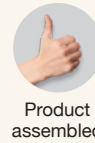

Product assembled



Untreated



10 mm

Wooden cover for CBS403023 and CBS403014 boxes



REF.CBSTP4030

EAN 8422341699347

Product without packaging: 40 x 30,5 x 2,8 cm



Wooden cover for CBS302014 box

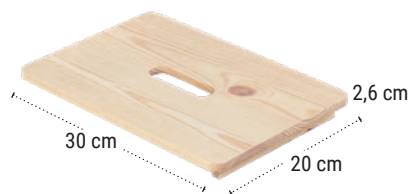

REF.CBSTP3020

EAN 8422341699330

Product without packaging: 30 x 20,1 x 2,8 cm



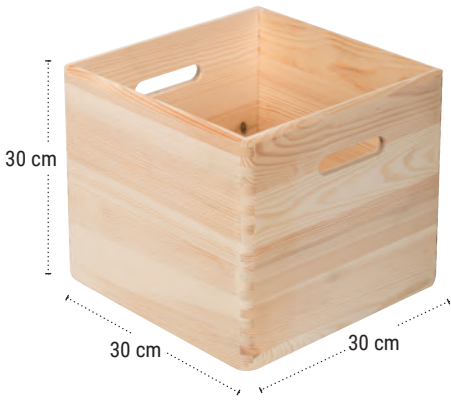

REF. CBS303030

EAN 8422341499053

Product without packaging: 30 x 30 x 30cm.

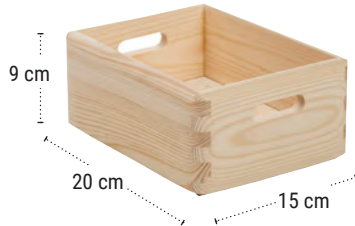

REF. CBS201509

EAN 8422341499251

Product without packaging: 20 x 15 x 9cm.



REF. CBS403007

EAN 8422341499510

Product without packaging: 40 x 30 x 7cm.

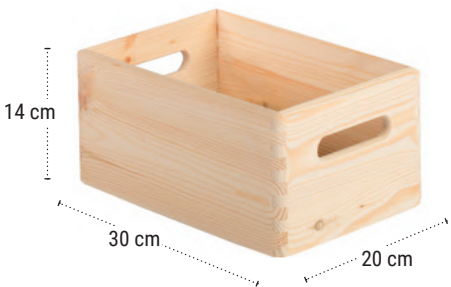

REF. CBS302014

EAN 8422341499947

Product without packaging: 30 x 20 x 14cm.

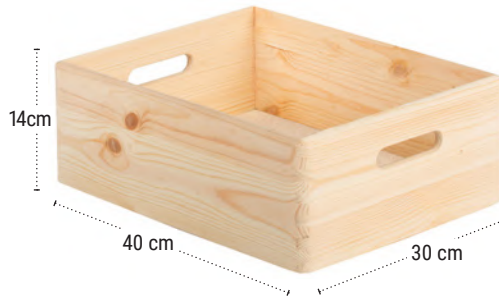

REF. CBS403014

EAN 8422341499923

Product without packaging: 40 x 30 x 14cm.

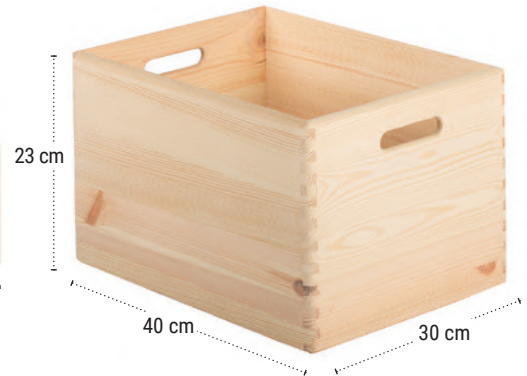

REF. CBS403023

EAN 8422341499930

Product without packaging: 40 x 30 x 23cm.

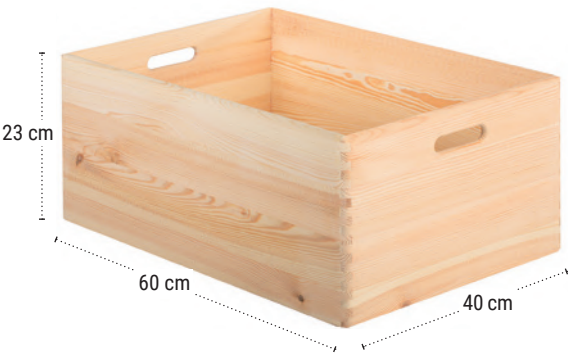

REF. CBS604023

EAN 8422341499916

Product without packaging: 60 x 40 x 23cm.

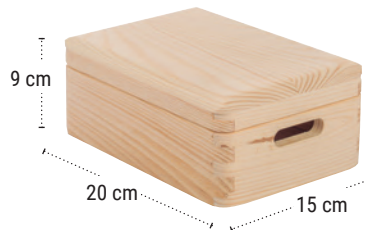

REF. CBT201509

EAN 8422341499268

Product without packaging: 20 x 15 x 9cm.



REF. CBT403023

EAN 8422341499893

Product without packaging: 40 x 30 x 23cm.



REF. CBT604023

EAN 8422341499879

Product without packaging: 60 x 40 x 23cm.

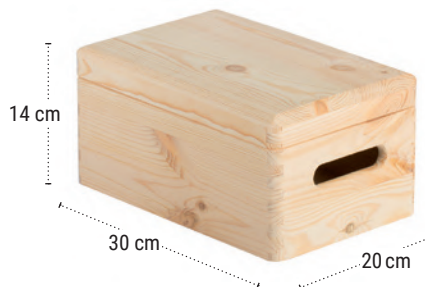

REF. CBT302014

EAN 8422341499909

Product without packaging: 30 x 20 x 14cm.

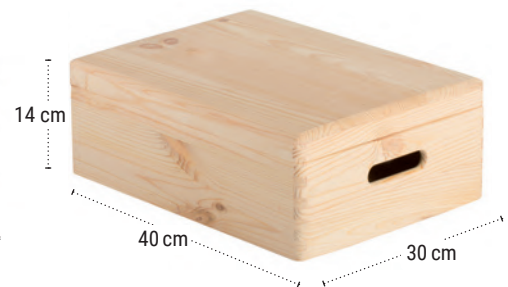

REF. CBT403014

EAN 8422341499886

Product without packaging: 40 x 30 x 14cm.

III. BOXES AND DRAWERS

EVOLUTION >



PEFC
PEFC/14-38-00151

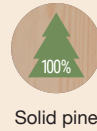

Solid pine wood



Untreated



Stackable

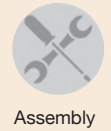

Assembly required

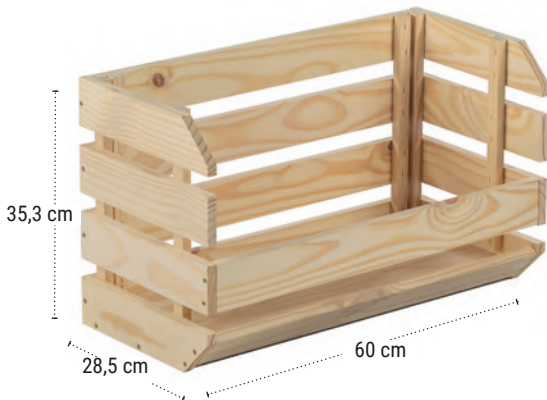

STACKABLE BOX

REF. EVCAPI.99

EAN 8422341399315

Packed product: 57,5 x 35 x 8 cm.



Stackable



A:70 mm
B:15 mm



Packed product



TROLLEY

REF. EV3CAR.99

EAN 8422341399155

Packed product: 39 x 35 x 31 cm.



A:37 mm
B:20 mm



Packed product

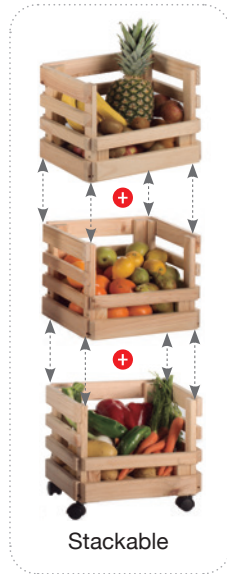

Stackable

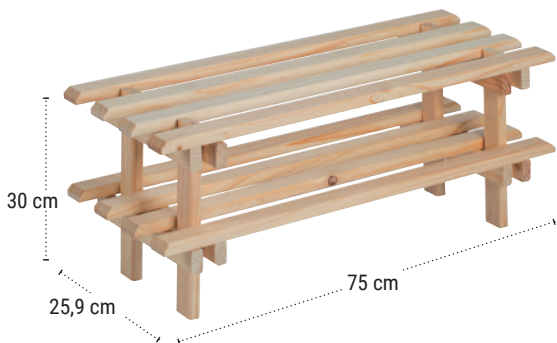

STACKABLE SHOE CABINET

REF. EVCH60.99

EAN 8422341399100

Packed product: 75 x 26 x 10 cm.



ES.EU / 049 / 00001



A:37 mm
B:20 mm



Packed product

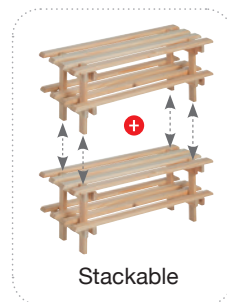

Stackable



TRUNK >



Solid pine wood



Untreated

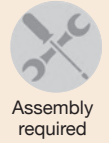

Assembly required



BASIC TRUNK

REF. BAUL70.99

EAN 8422341299646

Capacity: 85L

Packed product 75 x 47 x 9cm.



Packed product



DIY Ideas



DINAMIC TRUNK

REF. CF8040.99

EAN 8422341599098

Capacity: 135L

Packed product 82 x 49 x 8cm.



Packed product

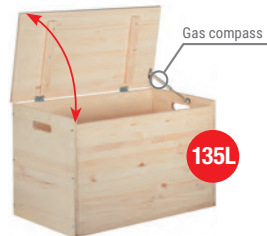

DECO TRUNK

REF. BB9038.99

EAN 8422341599821

Capacity: 78L

Packed product 88 x 49 x 6cm



Packed product







IV

PLEASURE AND GOOD TASTE

BOTTLE RACKS

A bottle of wine is synonymous with celebration, whether with friends, family, as a couple or by oneself. And to organise that pleasure are our bottle racks, simple, practical and ready to provide that touch of good taste and organisation to our bottles.

With these wine racks it is possible to transform those bottles that are left piled up in a corner of the house into a beautiful collection of wines, tidy and ready to be enjoyed.

IV. BOTTLE RACKS



RIOJA EVOLUTIVO

Union piece Rioja

REF. RIEV00.99
EAN 8422341799061

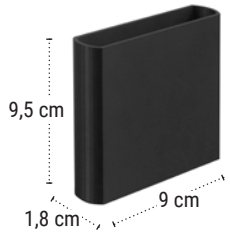

100%
Plástico
reciclado



Packed product
Closed box: 23 x 20,5 x 18,5 cm
Open box: 23x20,5x36,5 cm
Units per pack: 40

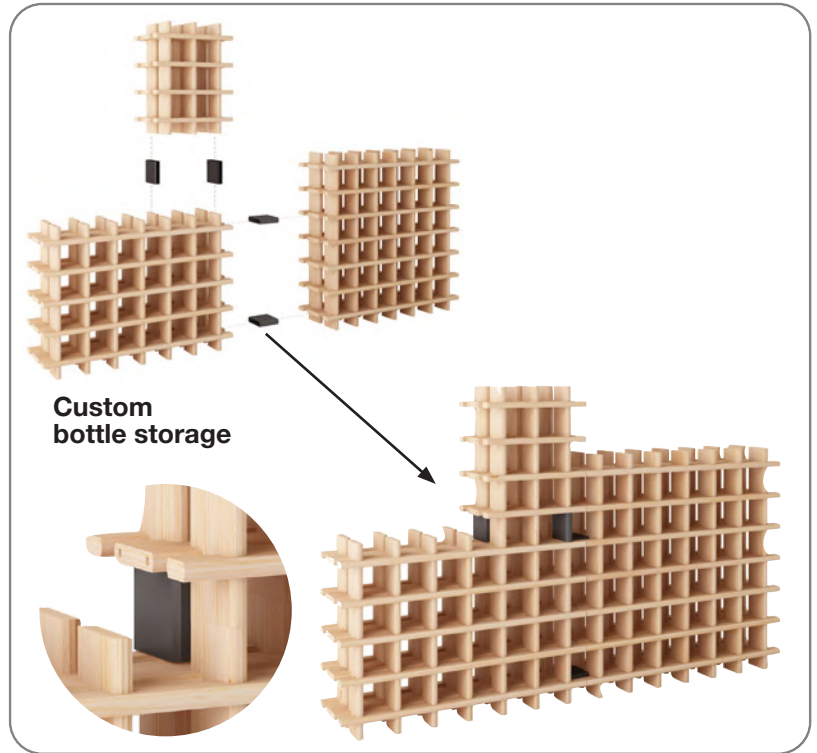

RIOJA Wooden wine racks

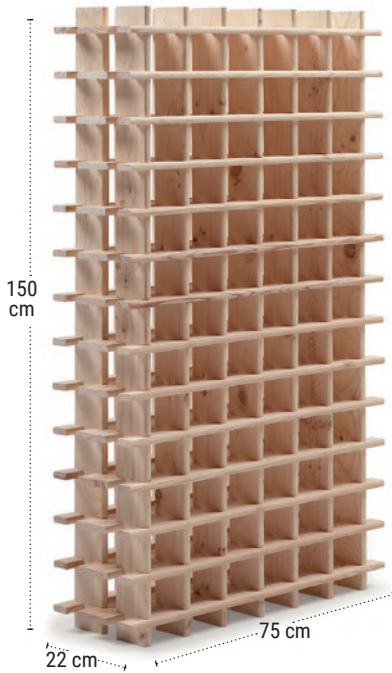
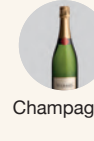
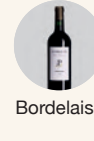
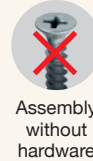
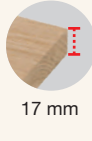
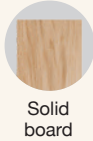

78 BOTTLES
REF. RI7800.99
EAN 8422341700098
Packed product:
153 x 25,5 x 19,5cm.

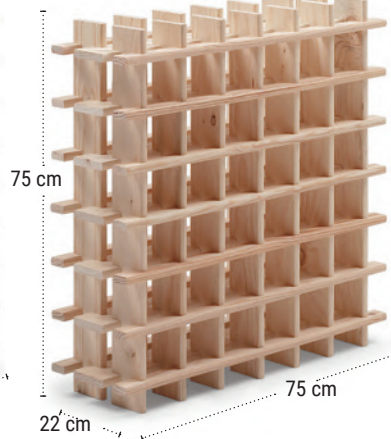

36 BOTTLES
REF. RI3600.99
EAN 8422341700074
Packed product:
77,5 x 25 x 20cm.

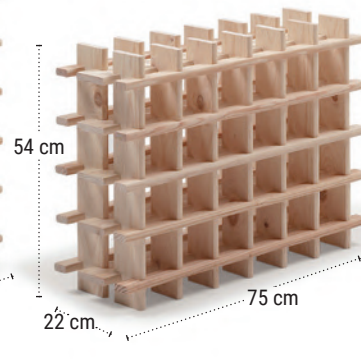

24 BOTTLES
REF. RI2400.99
EAN 8422341700050
Packed product:
77,5 x 22 x 19,5cm.

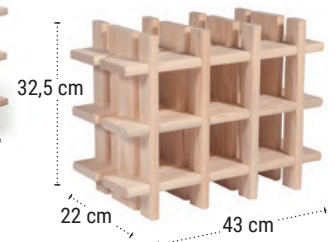

9 BOTTLES
REF. RI9000.99
EAN 8422341700043
Packed product:
43,3 x 17,7 x 12,2cm.



IV. BOTTLE RACKS



MERLOT 6 bottles stackable wine rack



ES.EU / 048 / 00001

PEFC/14-38-00151

Solid pine wood

Untreated wood

17 mm

Solid board

Stackable

Assembly without hardware

Assembly required

Bordelaise

Bourgogne

Champagne

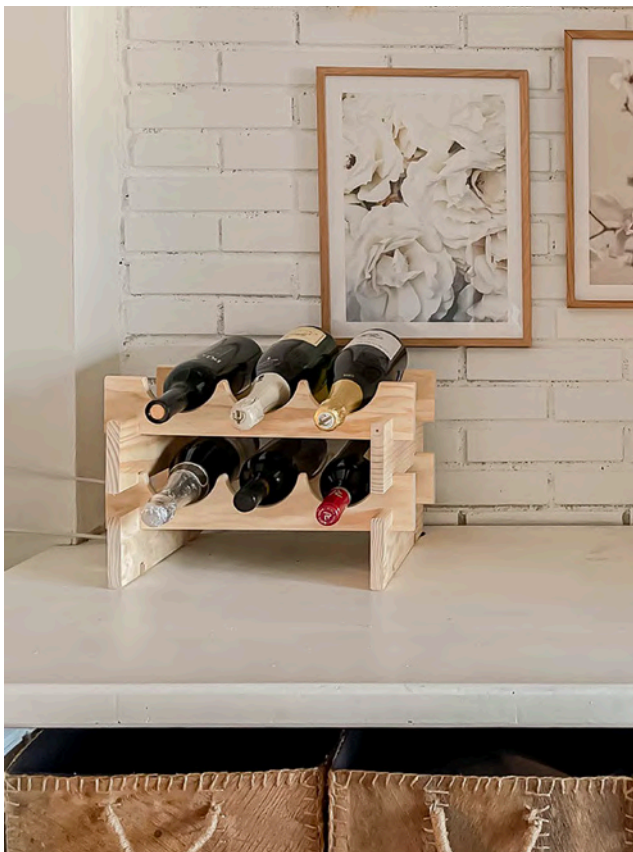

REF. ME6000.99

EAN 8422341700173

Packed product: 40 x 31 x 4,2cm.

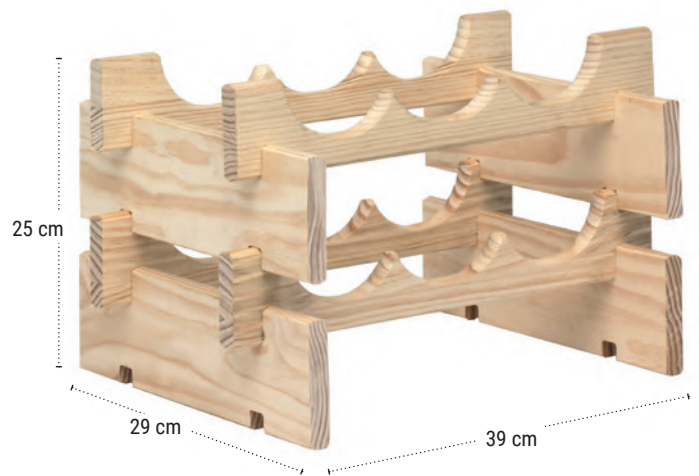

Packed product

KATEA

16 bottles stackable wine rack

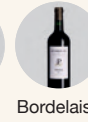
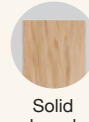
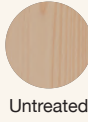

REF. KATE16.99

EAN 8422341799184

Packed product: 64,5 x 25 x 4 cm

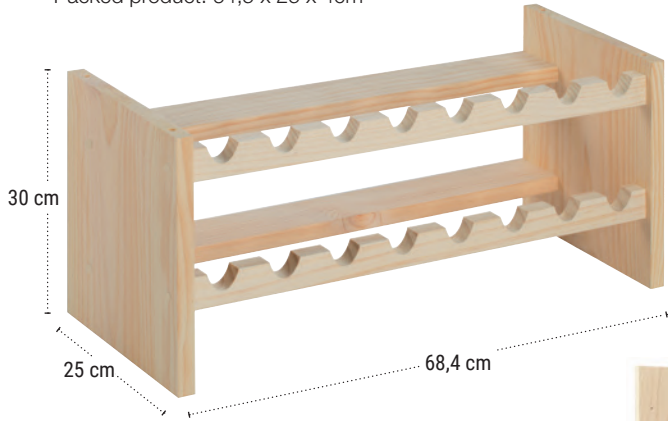

Packed product



T-6000

6 bottles wall wine rack

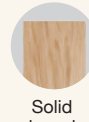
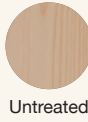

REF. TBOT60.99

EAN 8422341799191

Packed product: 60,5 x 7 x 4 cm.



Packed product



Europe Map



Commercial agents in Europe

AGENZIA ITALIANA: WIP SRL
 Via Vigentina 110/D, 27100 PAVIA
Paolo VERGANI
Sergio FRAZZINI
 Tel.: +39 0382.56.65.38
 Fax: +39 0382.56.60.49
 E-mail: info@wipdistribuzioni.it

Aizpea ETXEBERRIA (Sales Assistant)
 Tel.: +34 943 813 077
 Fax: +34 943 816 713
 E-mail: depot@astikitline.es

Country: Italy

Ander MUTIOZABAL (Key Account Manager)
 Tel.: +34 690 280 739
 E-mail: ander@astikitline.es

Commercial attention
 Tel.: +34 943 168 557
 Fax: +34 943 816 713
 E-mail: order@astikitline.es

Country: Spain

Frank ROOS
 Tel.: +31 653 537 373
 E-mail: info@roosmc.com

Aizpea ETXEBARRIA (Sales Assistant)
 Tel.: +34 943 813 077
 Fax: +34 943 816 713
 E-mail: depot@astikitline.es

Country: Germany, Holland

Commercial attention
 Tel.: 05 59 43 52 40
 Fax: +34 943 157 959
 E-mail: maite@astikitline.es

Facundo VILLAR (Key Account Manager)
 Tel.: Tel. 07 86 41 98 09
 E-mail: fvillar@astikitline.es

Country: France, Belgium

Pedro CARVALHO
 Tel.: 0351 927 142 891
 E-mail: pedro@ilmh.pt

Ander MUTIOZABAL (Key Account Manager)
 Tel.: +34 690 280 739
 E-mail: ander@astikitline.es

Commercial attention
 Tel.: +34 943 168 557
 Fax: +34 943 816 713
 E-mail: order@astikitline.es

Country: Portugal

ASTIGARRAGA

kit line

Olalde área, 3 – 20730 AZPEITIA
(GIPUZKOA)

Contacts in ASTIGARRAGA:

Frank Roos

North Europe Agent
Tel.: +31 653 537 373
info@roosmc.com

Aizpea Etxebarria

Sales Assistant
Tel.: +34 943 813 077
Fax: +34 943 816 713
depot@astikitline.es



Company Video

www.astikitline.com

Folow us on

